

QUANTUM[®] series

Light, extremely quiet and
low-vibration for high speeds
and accelerations

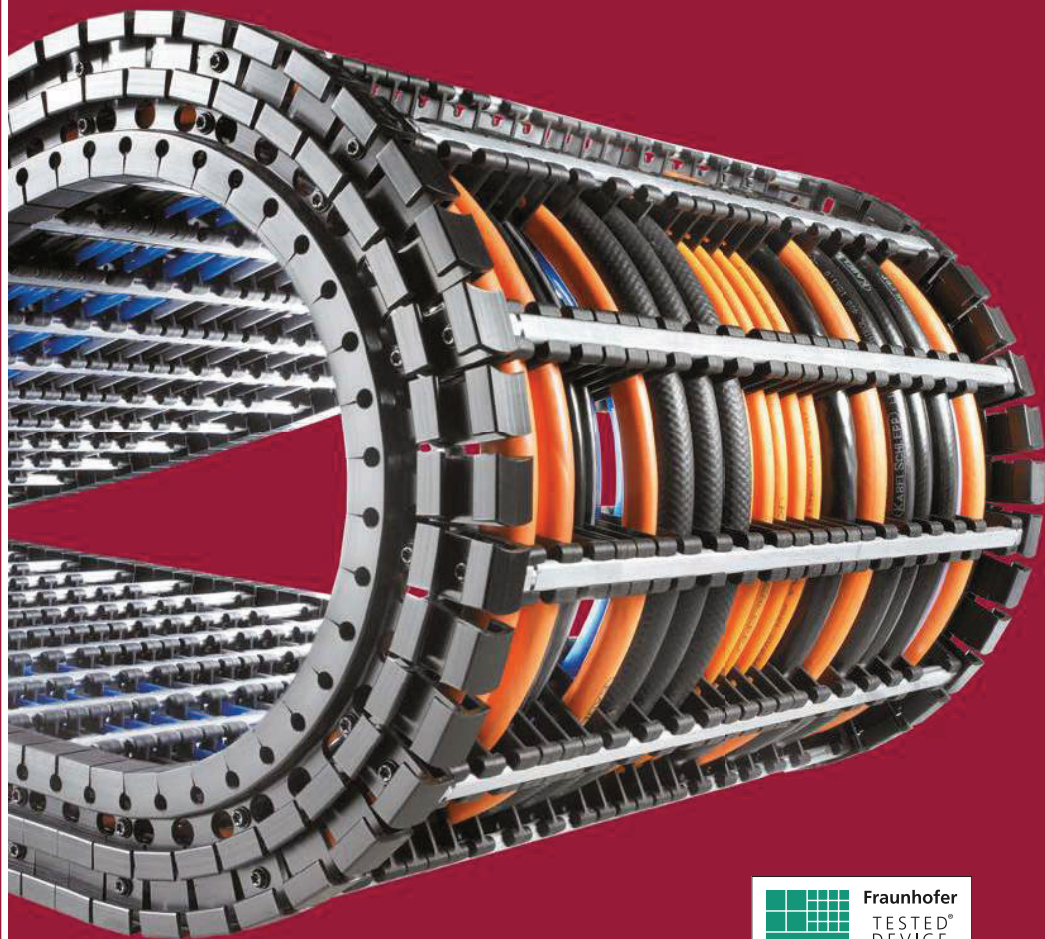

Trademarks are legally protected for the TSUBAKI KABELSCHLEPP GmbH
as a national or international registration in the following countries:
tsubaki-kabelschlepp.com/Trademarks

Subject to change.

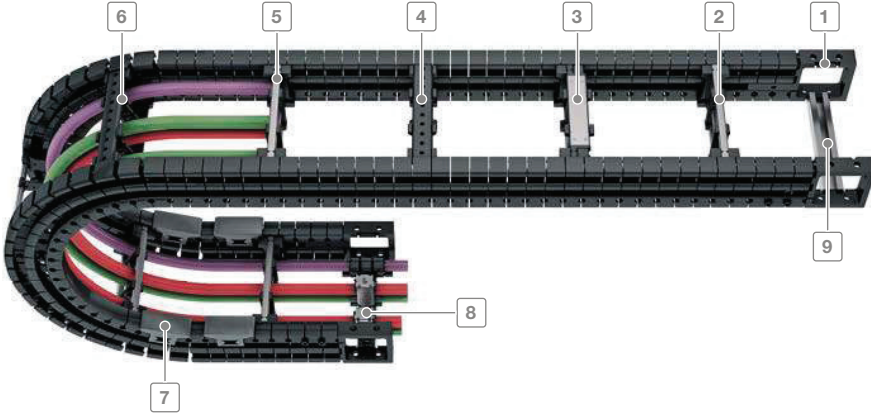

Inner heights



Inner widths



- 1 Universal end connectors (UMB)
- 2 Aluminum stays available in **1 mm width sections**
- 3 Aluminum stays in reinforced design
- 4 Plastic stays available in **8 or 16 mm width sections**
- 5 Can be opened quickly on the inside and the outside for cable laying
- 6 Fixable dividers
- 7 Replaceable glide shoes
- 8 Strain relief combs
- 9 C-rail for strain relief elements

Virtually no polygon effect

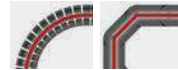

QUANTUM® Low-vibration operation Cable carrier with polygon effect

tsubaki-kabelschlepp.com/
quantum

Features

- Cleanroom compatible:
Cleanroom class 1 possible – no links, no link wear
- Extremely quiet, 31 db (A)*
- Extremely light
- For high accelerations up to 300 m/s²
- For high operating speeds up to 40 m/s
- Extremely long service life: ≥ 25 million motion cycles
- TÜV type tested as per 2PFG 1036/10.97
- Large selection of stay systems and separating options for cables



* Tested: Q060.100.100 by TÜV Rheinland. The sound pressure level for the measured area was measured at a distance of 0.5 m for smooth and jerky movements.



Ideal for highly dynamic applications



3D movements: the driver connection can be moved laterally and can be rotated by up to ± 30°



Side bands made from special plastic and steel cables in the support floor for an extremely long service life

Key for abbreviations
on page 12

Design guidelines
from page 38

Technical support:
technik@kabelschlepp.de

online-engineer.de
Cable Carrier Configurator

Type	Opening variant	Stay variant	h_i [mm]	h_G [mm]	B_i [mm]	B_k [mm]	B_i - grid [mm]	t [mm]	KR [mm]	Additional load ≤ [kg/m]	d_{max} [mm]
Q040											
		RE	28	40	28–284	$B_i + 40$	8	15	60–180	2.5	22
Q060											
		RS	38	60	38–500	$B_i + 52$	1	20	100–300	5	30
		RE	42	60	68–276	$B_i + 52$	8	20	100–300	5	33
Q080											
		RS	58	80	50–600	$B_i + 72$	1	25	170–500	8	46
		RV	58	80	50–600	$B_i + 72$	1	25	170–500	8	46
		RE	58	80	58–570	$B_i + 72$	16	25	170–500	8	46
Q100											
		RS	72	98	70–600	$B_i + 82$	1	30	180–600	12	57
		RV	72	98	70–600	$B_i + 82$	1	30	180–600	12	57
		RE	72	98	74–570	$B_i + 82$	16	30	180–600	12	57

Cleanroom compatible and long service life

Continuous side bands are used. In contrast to conventional hole-and-bolt connections, hardly any wear occurs (link abrasion), which makes QUANTUM® ideal for use in cleanrooms.











Extremely long service life through

- No link abrasion due to absence of hole-and-bolt connections
- Continuous side bands made from special plastic with integrated steel cables

Ideal for highly dynamic applications – extruded side bands

The QUANTUM® runs extremely quietly and with low vibrations. The absence of links and the very small pitch means that the so-called polygon effect is reduced to a minimum. Due to the very quiet running, the QUANTUM® cable carrier system is ideal for applications with low-vibration linear drives.

QUANTUM® series | Overview

Unsupported arrangement			Gliding arrangement			Inner distribution				Installation variants			Page
Travel length ≤ [m]	v_{max} ≤ [m/s]	a_{max} ≤ [m/s ²]	Travel length ≤ [m]	v_{max} ≤ [m/s]	a_{max} ≤ [m/s ²]	TS0	TS1	TS2	TS3	vertical hanging or standing	lying on the side	rotating arrangement	
										vertical hanging or standing	lying on the side	rotating arrangement	
3,2	40	300	100	20	7	•	•	•	–	•	•	–	368
5	30	160	150	15	7	•	•	•	•	•	•	–	374
5	30	160	150	15	7	•	•	•	•	•	•	–	378
6.4	25	100	180	12	6	•	•	•	•	•	•	–	384
6.4	25	100	180	12	6	•	•	•	•	•	•	–	386
6.4	25	100	180	12	6	•	•	•	•	•	•	–	390
7.8	20	70	200	10	5	•	•	•	•	•	•	–	396
7.8	20	70	200	10	5	•	•	•	•	•	•	–	398
7.8	20	70	200	10	5	•	•	•	•	•	•	–	402

Inner heights



Inner widths



[tsubaki-kabelschlepp.com/
quantum](http://tsubaki-kabelschlepp.com/quantum)

Q040

Key for abbreviations
on page 12



Pitch
15 mm



Inner height
28 mm



Inner widths
28 – 284 mm

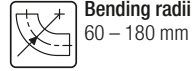

Bending radii
60 – 180 mm

Stay variants

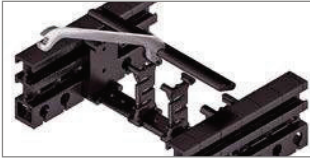

Plastic stay RE page 368

Frame screw-in stay

- Plastic profile bars for light and medium loads.
Assembly without screws.
- **Outside/inside:** release by rotating 90°.

Design guidelines
from page 38

Technical support:
technik@kabelschlepp.de



TOTALTRAX® complete systems

Benefit from the advantages of the TOTALTRAX® complete system. A complete delivery from one source – with a warranty certificate on request! Learn more at tsubaki-kabelschlepp.com/totaltrax



TRAXLINE® cables for cable carriers

Hi-flex electric cables which were especially developed, optimized and tested for use in cable carriers can be found at traxline.de

Q040 | Installation dim. | Unsupported · Gliding

Unsupported arrangement

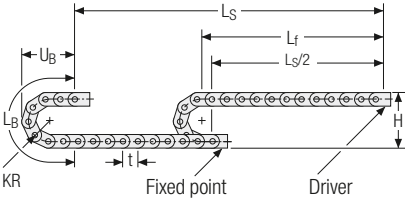

KR [mm]	H [mm]	L _B [mm]	U _B [mm]
60	175	369	178
75	205	416	193
90	235	463	208
110	275	526	228
150	355	651	268
180	415	746	298

Inner heights



Inner widths



Load diagram for unsupported length depending on the additional load.

Sagging of the cable carrier is technically permitted for extended travel lengths, depending on the specific application.

Intrinsic cable carrier weight $q_k = 0.8 \text{ kg/m}$. For other inner widths, the maximum additional load changes.

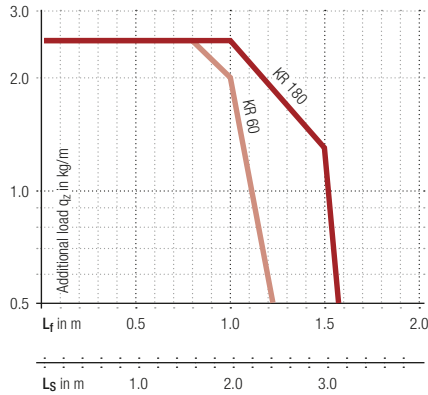

Velocity
up to 40 m/s

Acceleration
up to 300 m/s²

Travel length
up to 3.2 m

Additional load
up to 2.5 kg/m

tsubaki-kabelschlepp.com/quantum

Gliding arrangement

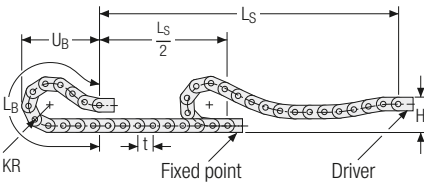

Velocity
up to 20 m/s

Acceleration
up to 15 m/s²

Travel length
up to 100 m

Additional load
up to 2.5 kg/m

Glide shoes have to be used for gliding applications.

The gliding cable carrier has to be routed in a channel. See p. 654.



Our technical support can provide help for gliding arrangements:
technik@kabelschlepp.de

Q040 RE | Dimensions · Technical data

Plastic stay RE – screw-in frame stay

- Plastic profile bars for light and medium loads. Assembly without screws.
- Available customized in **8 mm sections**.
- **Outside/inside:** release by rotating 90°.

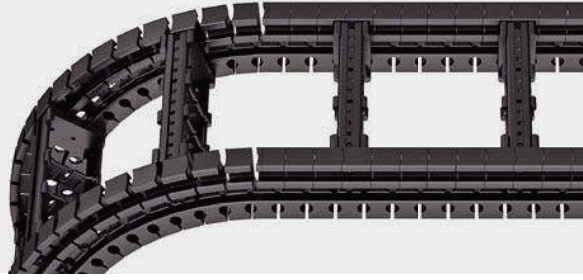

Key for abbreviations
on page 12



Stays on every 6th section,
standard (HS: half-stayed)



Stays on every 3rd section
(VS: fully-stayed)



8 mm B_i 28 – 284 mm in
8 mm width sections

Design guidelines
from page 38

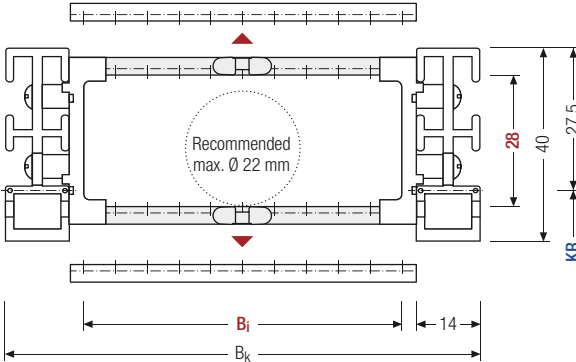

The maximum cable diameter strongly depends on the bending radius and the desired cable type. Please contact us.

Calculating the cable carrier length

Cable carrier length L_k

$$L_k \approx \frac{L_s}{2} + L_B$$

Cable carrier length L_k
rounded to pitch t

Technical support:
technik@kabelschlepp.de

online-engineer.de
Cable Carrier Configurator

h _i [mm]	h _G [mm]	B _i [mm]*	B _k [mm]	KR [mm]				q _k [kg/m]		
28	40	28 – 284	B _i + 40	60	75	90	110	150	180	0.63 – 0.98

* in 8 mm width sections

Order example

Q040 -
 108 -
 RE -
 150 -
 1290 -
 HS

Type B_i [mm] Stay variant KR [mm] L_k [mm] Stay arrangement

Our technical support can provide help for gliding arrangements: technik@kabelschlepp.de

Divider systems

The divider system is mounted on each crossbar as a standard – on every 6th section for stay mounting (HS).

As a standard, dividers or the complete divider system (dividers with height separations) are movable in the cross section (**Version A**).

For applications with lateral accelerations and applications with the cable carrier rotated by 90°, the dividers can easily be fixed by turning the frame stay by 180°. The arresting cams click into place in the locking grids in the crossbar (**Version B**). The groove in the frame stay faces outwards.

Inner heights



Inner widths



Increments



Divider system TSO without height separation

Vers.	a _T min [mm]	a _x min [mm]	a _c min [mm]	a _x grid [mm]	n _T min
A	8	8	5.2	–	–
B	14	8	5.2	8	–

The dividers are movable within the cross section (version A) or fixed (version B).

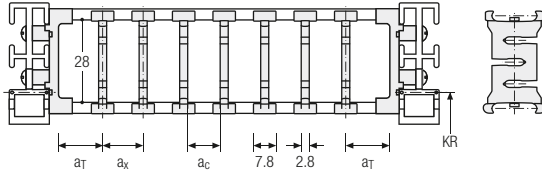

Divider system TS1 with continuous height separation

Vers.	a _T min [mm]	a _x min [mm]	a _c min [mm]	a _x grid [mm]	n _T min
A	8	8	5.2	–	2
B	14	8	5.2	8	2

The dividers are movable within the cross section (version A) or fixed (version B).

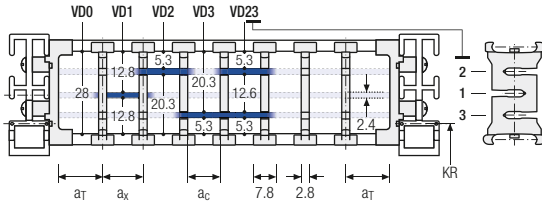

Divider system TS2 with partial height separation

Vers.	a _T min [mm]	a _x min [mm]	a _c min [mm]	a _x grid [mm]	n _T min
B	12	8*/ 24	5.2*/ 21.2	8	2

* for VR0

With grid distribution (8 mm grid). The dividers are fixed by the height separation, the complete divider system is fixed (version B).

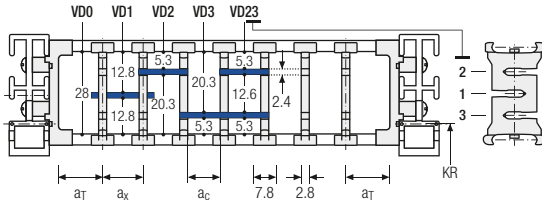

tsubaki-kabelschlepp.com/
quantum

Order example

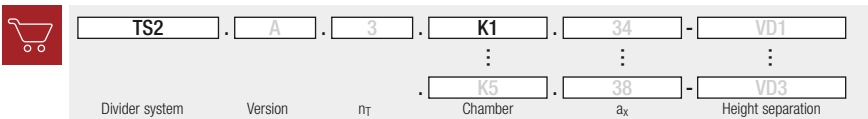

Q040 | End connectors

Universal end connectors UMB – plastic (standard)

The universal end connectors (UMB) are made from plastic and can be mounted from the top, from the bottom or face on.

Key for abbreviations
on page 12

Design guidelines
from page 38

Technical support:
technik@kabelschlepp.de

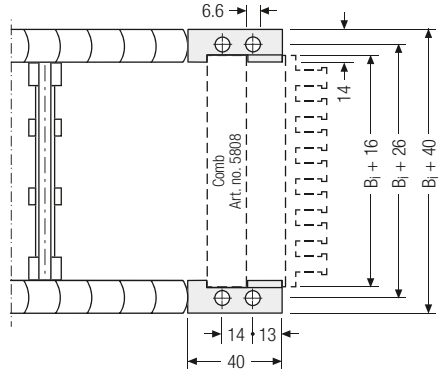
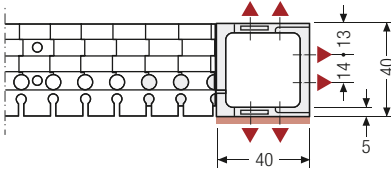

▲ Assembly options

 Recommended tightening torque:
5 Nm for screws M5 - 8.8

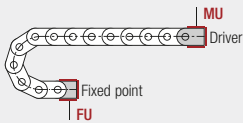

Connection point

F – fixed point
M – driver

Connection type

U – universal end connector

Order example

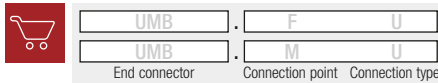

 We recommend the use of strain reliefs before driver and fixed point. See from p. 706.

More product information online



Assembly instructions etc.:
Additional info via your
smartphone or check online at
[tsubaki-kabelschlepp.com/
support](http://tsubaki-kabelschlepp.com/support)



Configure your custom
cable carrier here:
onlineengineer.de



QUANTUM®
series

Inner heights



Inner widths



Increments



[tsubaki-kabelschlepp.com/
quantum](http://tsubaki-kabelschlepp.com/quantum)

Subject to change.

Q060

Key for abbreviations
on page 12



Pitch
20 mm



Inner heights
38 – 42 mm



Inner widths
38 – 500 mm



Bending radii
100 – 300 mm

Design guidelines
from page 38

Stay variants

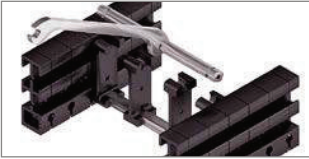

Aluminum stay RS page 374

Standard frame stay “The standard”

- Aluminum profile bars for light to medium loads.
Assembly without screws.
- **Outside/inside:** release by rotating 90°.

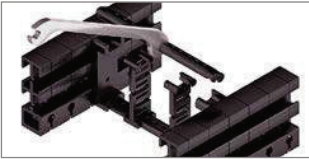

Plastic stay RE page 378

Frame screw-in stay

- Plastic profile bars for light and medium loads.
Assembly without screws.
- **Outside/inside:** release by rotating 90°.

Technical support:
technik@kabelschlepp.de



TOTALTRAX® complete systems

Benefit from the advantages of the TOTALTRAX® complete system. A complete delivery from one source – with a warranty certificate on request! Learn more at tsubaki-kabelschlepp.com/totaltrax



TRAXLINE® cables for cable carriers

Hi-flex electric cables which were especially developed, optimized and tested for use in cable carriers can be found at traxline.de

Q060 | Installation dim. | Unsupported · Gliding

Unsupported arrangement

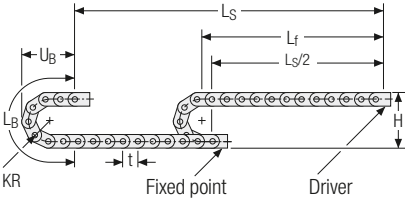

KR [mm]	H [mm]	LB [mm]	UB [mm]
100	288	554	264
120	328	617	284
150	388	711	314
190	468	837	354
250	588	1025	414
300	688	1182	464

Inner heights

38
42

Inner widths

38
500

Load diagram for unsupported length depending on the additional load.

Sagging of the cable carrier is technically permitted for extended travel lengths, depending on the specific application.

Intrinsic cable carrier weight $q_k = 1.5 \text{ kg/m}$. For other inner widths, the maximum additional load changes.

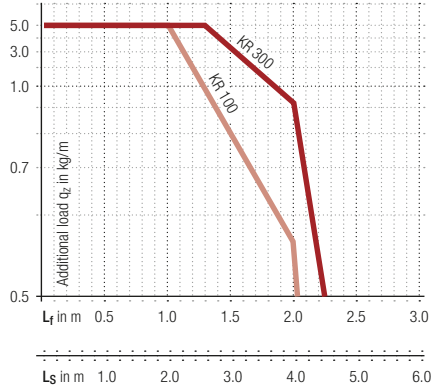

tsubaki-kabelschlepp.com/
quantum



Velocity
up to 30 m/s



Acceleration
up to 160 m/s²



Travel length
up to 5 m



Additional load
up to 5 kg/m

Gliding arrangement

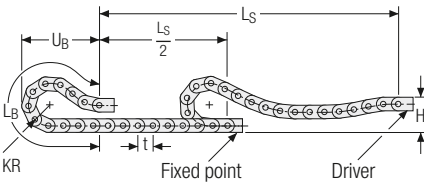

Velocity
up to 15 m/s



Acceleration
up to 7 m/s²



Travel length
up to 150 m



Additional load
up to 5 kg/m

Glide shoes have to be used for gliding applications.

The gliding cable carrier has to be routed in a channel.
See p. 654.



Our technical support can provide help for gliding arrangements:
technik@kabelschlepp.de

Aluminum stay RS – standard frame stay

- Extremely quick to open and close
- Aluminum profile bars for light to medium loads.
Assembly without screws.
- Available customized in **1 mm sections**.
- **Outside/inside:** release by rotating 90°.

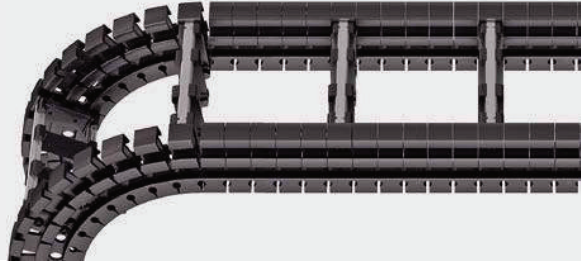

Key for abbreviations on page 12



Stays on every 6th section, **standard (HS: half-stayed)**



Stays on every 3rd section **(VS: fully-stayed)**



1 mm B_i 38 – 500 mm in **1 mm width sections**

Design guidelines from page 38

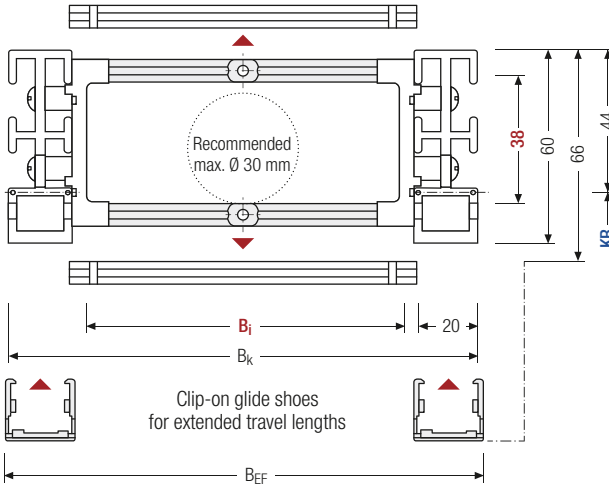

i The maximum cable diameter strongly depends on the bending radius and the desired cable type. Please contact us.

Calculating the cable carrier length

Cable carrier length L_k

$$L_k \approx \frac{L_s}{2} + L_B$$

Cable carrier length L_k rounded to pitch t

Technical support: technik@kabelschlepp.de

h _i [mm]	h _G [mm]	h _{G'} [mm]	B _i [mm]*	B _k [mm]	B _{EF} [mm]	KR [mm]				q _k [kg/m]		
38	60	66	38 – 500	B _i + 52	B _i + 56	100	120	150	190	250	300	1.25 – 2.40

* in 1 mm width sections

Order example

Q060 -
 200 -
 RS -
 150 -
 1540
HS

Type B_i [mm] Stay variant KR [mm] L_k [mm] Stay arrangement

Our technical support can provide help for gliding arrangements: technik@kabelschlepp.de

Divider systems

The divider system is mounted on each crossbar as a standard – on every 6th section for stay mounting (HS).

As a standard, dividers or the complete divider system (dividers with height separations) are movable in the cross section (**Version A**).

For applications with lateral acceleration and rotated by 90°, the dividers can be attached by simply clipping onto a socket (available as an accessory).

The socket additionally acts as a spacer between the dividers and is available in 1 mm sections between 3 – 50 mm (**Version B**).

Inner heights



Inner widths



Increments



Divider system TS0 without height separation

Vers.	a _T min [mm]	a _x min [mm]	a _c min [mm]	n _T min
A	13.5	13	10	–

The dividers can be moved in the cross section.

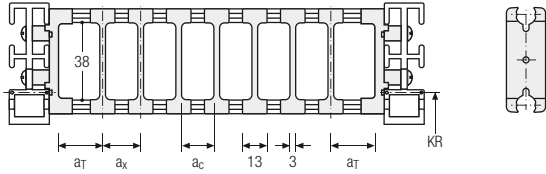

Divider system TS1 with continuous height separation

Vers.	a _T min [mm]	a _T max [mm]	a _x min [mm]	a _c min [mm]	n _T min
A	13.5	40	13	10	2

The dividers can be moved in the cross section.

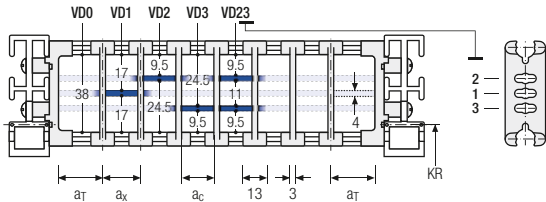

Divider system TS2 with partial height separation

Vers.	a _T min [mm]	a _x min [mm]	a _c min [mm]	n _T min
A	13.5	13	7	2

With grid distribution (1 mm grid). The dividers are attached by the height separation; the grid can be moved in the cross section.

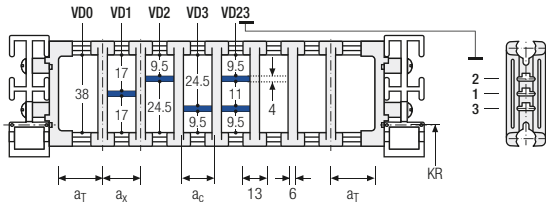

tsubaki-kabelschlepp.com/
quantum



TRAXLINE® cables for cable carriers

Hi-flex electric cables which were especially developed, optimized and tested for use in cable carriers can be found at traxline.de

QO60 RS | Inner distribution | TS3

Divider system TS3 with height separation consisting of plastic partitions

Vers.	a _T min [mm]	a _x min [mm]	a _c min [mm]	n _T min
A	11	16 / 42*	8	2

* For aluminum partitions

The dividers are fixed with the partitions. The entire divider system can be moved in the cross section.

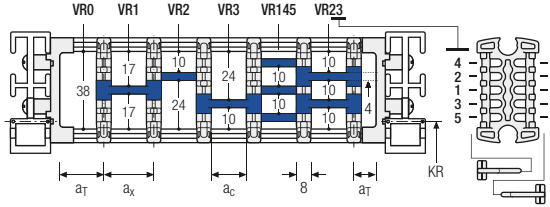

Key for abbreviations on page 12

Design guidelines from page 38

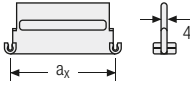

Aluminum partitions with 1 mm increments with a_x > 42 mm are also available.

a _x (center distance of dividers) [mm]											
a _c (nominal width of inner chamber) [mm]											
16	18	23	28	32	33	38	43	48	58	64	68
8	10	15	20	24	25	30	35	40	50	56	60
78	80	88	96	112	128	144	160	176	192	208	
70	72	80	88	104	120	136	152	168	184	200	

When using **plastic partitions with a_x > 112 mm**, we recommend an additional center support with a **twin divider** (S_T = 4 mm). Twin dividers are also suitable for retrofitting in the partition system.

Order example



TS3	A	3	K1	34	VR1
			⋮	⋮	⋮
			K5	38	VR5
Divider system	Version	n _T	Chamber	a _x	Height separation

Please state the designation of the divider system (TS0, TS1,...), the version, and the number of dividers per cross section [n_T]. In addition, please also enter the chambers [K] from left to right, as well as the assembly distances [a_T/a_x].

When using divider systems with height separation (TS1 – TS3), please additionally state the positions (e.g. VD23) as seen from the left driver belt. You are welcome to add a sketch to your order.

Technical support: technik@kabelschlepp.de

online-engineer.de
Cable Carrier Configurator

More product information online



Assembly instructions etc.: Additional info via your smartphone or check online at tsubaki-kabelschlepp.com/support



Configure your custom cable carrier here: onlineengineer.de

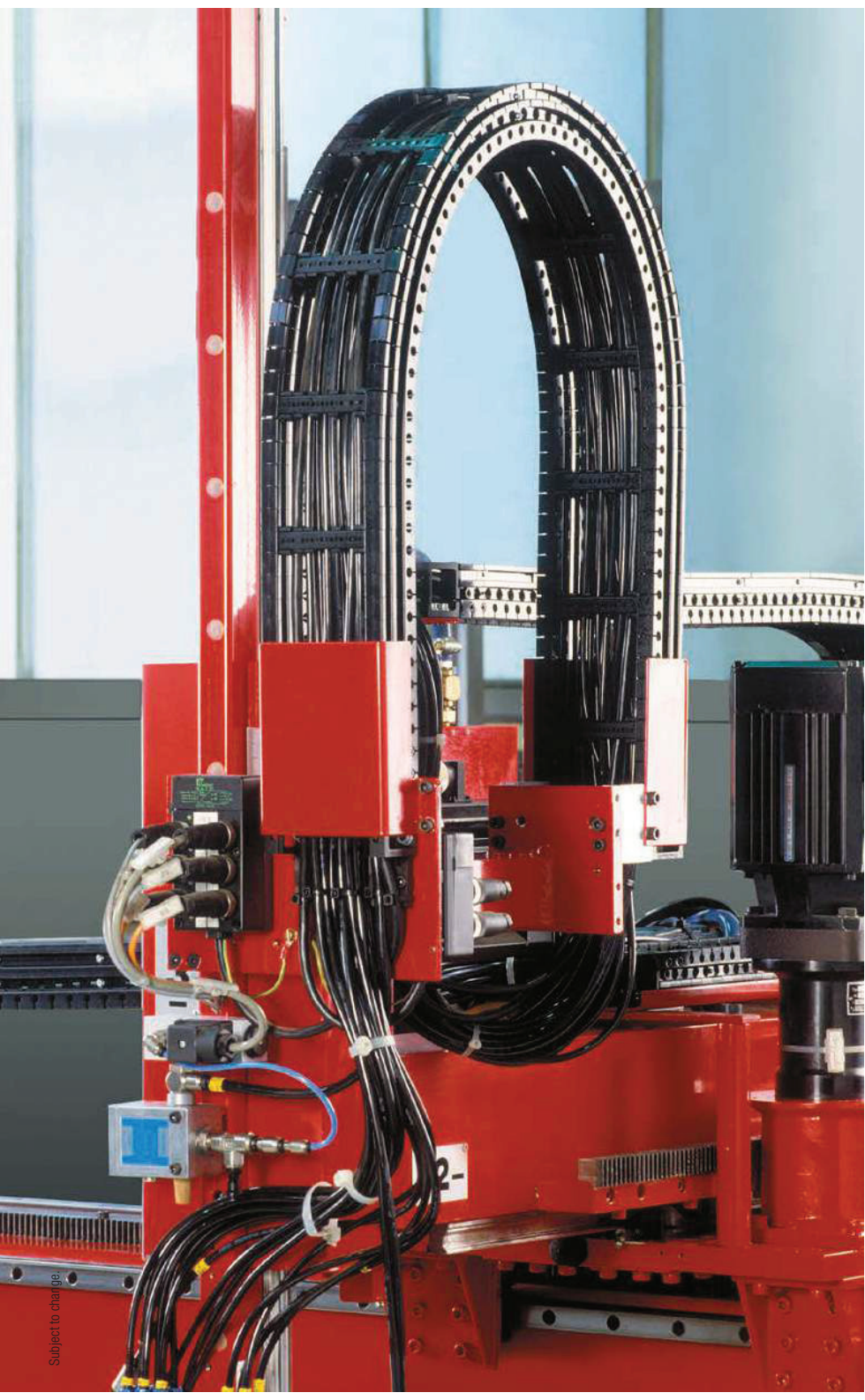

QUANTUM®
series

Inner heights



Inner widths



Increments



[tsubaki-kabelschlepp.com/
quantum](http://tsubaki-kabelschlepp.com/quantum)

Q060 RE | Dimensions · Technical data

Plastic stay RE – frame screw-in stay

- Plastic profile bars for light and medium loads. Assembly without screws.
- Available customized in **8 mm sections**.
- **Outside/inside:** release by rotating 90°.



Key for abbreviations
on page 12



Stays on every 6th section,
standard (HS: half-stayed)



Stays on every 3rd section
(VS: fully-stayed)



8 mm B_i 68 – 276 mm in
8 mm width sections

Design guidelines
from page 38

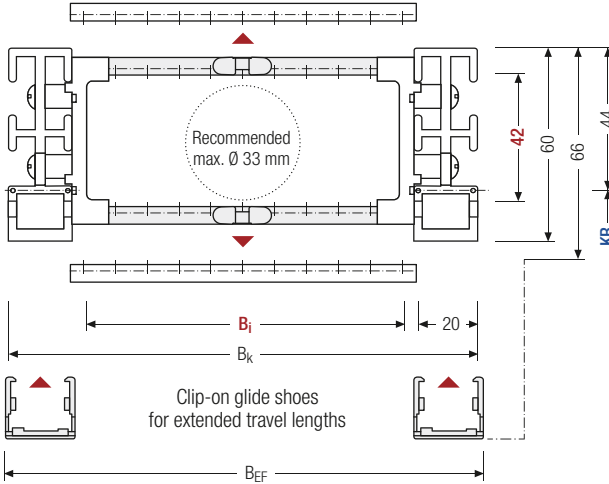

The maximum cable diameter strongly depends on the bending radius and the desired cable type. Please contact us.

Calculating the cable carrier length

Cable carrier length L_k

$$L_k \approx \frac{L_s}{2} + L_B$$

Cable carrier length L_k
rounded to pitch t

Technical support:
technik@kabelschlepp.de

online-engineer.de
Cable Carrier Configurator

h_i [mm]	h_G [mm]	$h_{G'}$ [mm]	B_i [mm]*	B_k [mm]	B_{EF} [mm]	KR [mm]				q_k [kg/m]		
42	60	66	68 – 276	$B_i + 52$	$B_i + 56$	100	120	150	190	250	300	1.16 – 1.54

* in 8 mm width sections

Order example

Q060 -
 196 -
 RE -
 150 -
 1540
HS

Type B_i [mm] Stay variant KR [mm] L_k [mm] Stay arrangement

Our technical support can provide help for gliding arrangements: technik@kabelschlepp.de

Divider systems

The divider system is mounted on each crossbar as a standard – on every 6th section for stay mounting (HS).

As a standard, dividers or the complete divider system (dividers with height separations) are movable in the cross section (**Version A**).

For applications with lateral accelerations and applications with the cable carrier rotated by 90°, the dividers can easily be fixed by turning the frame stay by 180°. The arresting cams click into place in the locking grids in the crossbar (**Version B**). The groove in the frame stay faces outwards.

Inner heights



Inner widths



Increments



Divider system TSO without height separation

Vers.	a _T min [mm]	a _x min [mm]	a _c min [mm]	a _x grid [mm]	Π _T min
A	14	13	8.8	–	–
B	14	16	11.8	8	–

The dividers are movable within the cross section (version A) or fixed (version B).

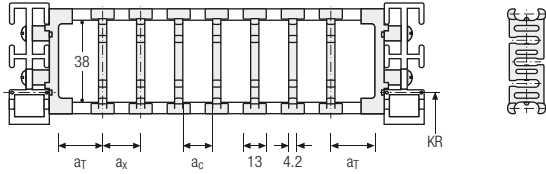

Divider system TS1 with continuous height separation

Vers.	a _T min [mm]	a _x min [mm]	a _c min [mm]	a _x grid [mm]	Π _T min
A	14	13	8.8	–	2

The dividers can be moved in the cross section.

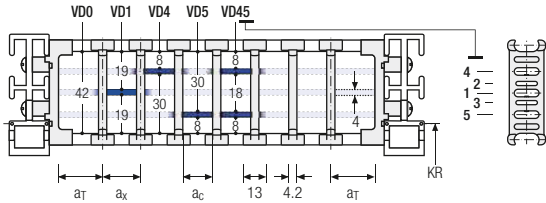

Divider system TS2 with partial height separation

Vers.	a _T min [mm]	a _x min [mm]	a _c min [mm]	Π _T min
A	14	13	8.8	2
B	14	16	11.8	2

With grid distribution (8 mm grid). The dividers are attached by the height separation; the grid can be moved in the cross section.

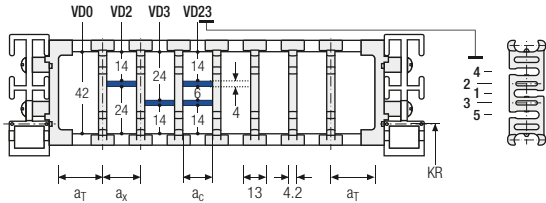

tsubaki-kabelschlepp.com/quantum



TOTALTRAX® complete systems

Benefit from the advantages of the TOTALTRAX® complete system. A complete delivery from one source – with a warranty certificate on request! Learn more at tsubaki-kabelschlepp.com/totaltrax

QO60 RE | Inner distribution | TS3

Divider system TS3 with height separation consisting of plastic partitions

Vers.	a _T min [mm]	a _x min [mm]	a _c min [mm]	n _T min
A	11	16 / 42*	8	2

* For aluminum partitions

The dividers are fixed with the partitions.
The entire divider system can be moved in the cross section.

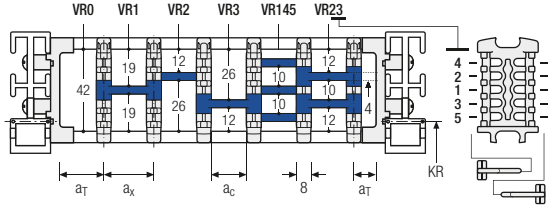

Key for abbreviations
on page 12

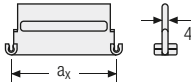

Aluminum partitions with 1 mm increments with a_x > 42 mm are also available.

a _x (center distance of dividers) [mm]											
a _c (nominal width of inner chamber) [mm]											
16	18	23	28	32	33	38	43	48	58	64	68
8	10	15	20	24	25	30	35	40	50	56	60
78	80	88	96	112	128	144	160	176	192	208	
70	72	80	88	104	120	136	152	168	184	200	

When using **plastic partitions with a_x > 112 mm**, we recommend an additional center support with a **twin divider** (S_T = 4 mm). Twin dividers are also suitable for retrofitting in the partition system.

Design guidelines
from page 38

Order example

TS3 . A . 2 . K1 . 16 - VD1
⋮ ⋮ ⋮
K5 . 208 - VD5
⋮ ⋮ ⋮

Divider system Version n_T Chamber a_x Height separation

Please state the designation of the divider system (TS0, TS1,...), the version, and the number of dividers per cross section [n_T]. In addition, please also enter the chambers [K] from left to right, as well as the assembly distances [a_T/a_x].

When using divider systems with height separation (TS1 – TS3), please additionally state the positions (e.g. VD23) as seen from the left driver belt. You are welcome to add a sketch to your order.

Technical support:
technik@kabelschlepp.de



TOTALTRAX® complete systems

Benefit from the advantages of the TOTALTRAX® complete system. A complete delivery from one source – with a warranty certificate on request! Learn more at tsubaki-kabelschlepp.com/totaltrax



TRAXLINE® cables for cable carriers

Hi-flex electric cables which were especially developed, optimized and tested for use in cable carriers can be found at traxline.de

Q060 | End connectors

Universal end connectors UMB – plastic (standard)

The universal end connectors (UMB) are made from plastic and can be mounted from the top, from the bottom or face on.

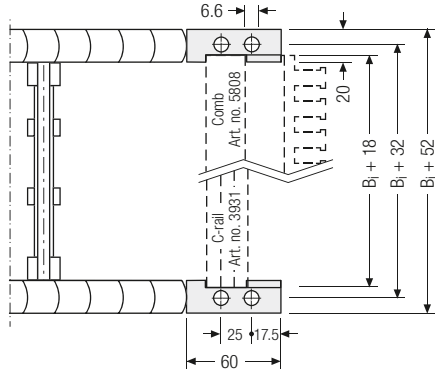
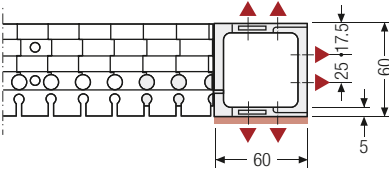

▲ Assembly options

Recommended tightening torque:
10 Nm

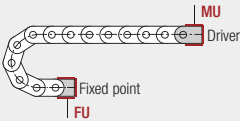

Connection point

F – fixed point
M – driver

Connection type

U – universal end connector

Order example



UMB	.	F	U
UMB	.	M	U
End connector		Connection point	Connection type



We recommend the use of strain reliefs before driver and fixed point. See from p. 706.

More product information online



Assembly instructions etc.:
Additional info via your smartphone or check online at tsubaki-kabelschlepp.com/support



Configure your custom cable carrier here:
onlineengineer.de

QUANTUM®
series

Inner heights



Inner widths



tsubaki-kabelschlepp.com/quantum

Q080

Key for abbreviations
on page 12



Pitch
20 mm



Inner height
58 mm



Inner widths
50 – 600 mm



Bending radii
170 – 500 mm

Stay variants

Design guidelines
from page 38

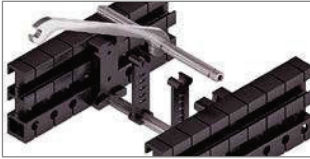

Aluminum stay RS page 384

Standard frame stay “The standard”

- Aluminum profile bars for light to medium loads. Assembly without screws.
- **Outside/inside:** release by rotating 90°.

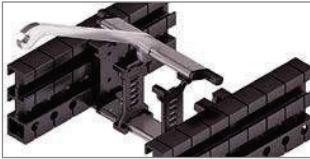

Aluminum stay RV page 386

Frame stay, reinforced

- Aluminum profile bars with plastic adapter for medium to high loads and large cable carrier widths. Assembly without screws.
- **Outside/inside:** release by rotating 90°.

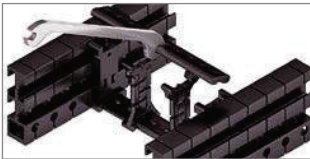

Plastic stay RE page 390

Frame screw-in stay

- Plastic profile bars for light and medium loads. Assembly without screws.
- **Outside/inside:** release by rotating 90°.

Technical support:
technik@kabelschlepp.de



TOTALTRAX® complete systems

Benefit from the advantages of the TOTALTRAX® complete system. A complete delivery from one source – with a warranty certificate on request! Learn more at tsubaki-kabelschlepp.com/totaltrax



TRAXLINE® cables for cable carriers

Hi-flex electric cables which were especially developed, optimized and tested for use in cable carriers can be found at traxline.de

Q080 | Installation dim. | Unsupported · Gliding

Unsupported arrangement

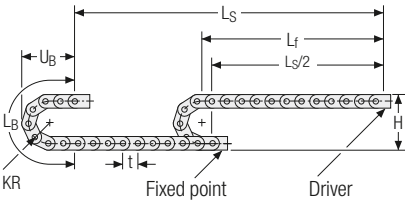

KR [mm]	H [mm]	LB [mm]	UB [mm]
170	457	834	379
200	517	928	409
250	617	1085	459
320	757	1305	529
420	957	1619	629
500	1117	1870	709

Inner heights



Inner widths



Load diagram for unsupported length depending on the additional load.

Sagging of the cable carrier is technically permitted for extended travel lengths, depending on the specific application.

Intrinsic cable carrier weight $q_k = 2.5 \text{ kg/m}$. For other inner widths, the maximum additional load changes.

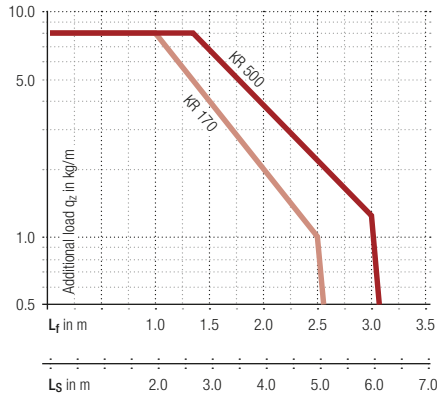

tsubaki-kabelschlepp.com/
quantum

 **Velocity**
up to 25 m/s

 **Acceleration**
up to 100 m/s²

 **Travel length**
up to 6.4 m

 **Additional load**
up to 8 kg/m

Gliding arrangement

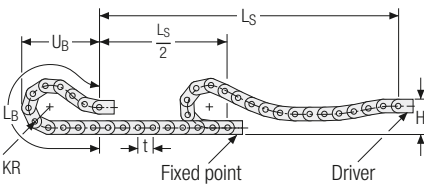

 **Velocity**
up to 12 m/s

 **Acceleration**
up to 6 m/s²

 **Travel length**
up to 180 m

 **Additional load**
up to 8 kg/m

Glide shoes have to be used for gliding applications.

The gliding cable carrier has to be routed in a channel.
See p. 654.



Our technical support can provide help for gliding arrangements:
technik@kabelschlepp.de

Aluminum stay RS – standard frame stay

- Extremely quick to open and close
- Aluminum profile bars for light to medium loads.
Assembly without screws.
- Available customized in **1 mm sections**.
- **Outside/inside:** release by rotating 90°.



Key for abbreviations on page 12



Stays on every 8th section,
standard (HS: half-stayed)



Stays on every 4th section
(VS: fully-stayed)



1 mm B_i 50 – 600 mm in
1 mm width sections

Design guidelines from page 38

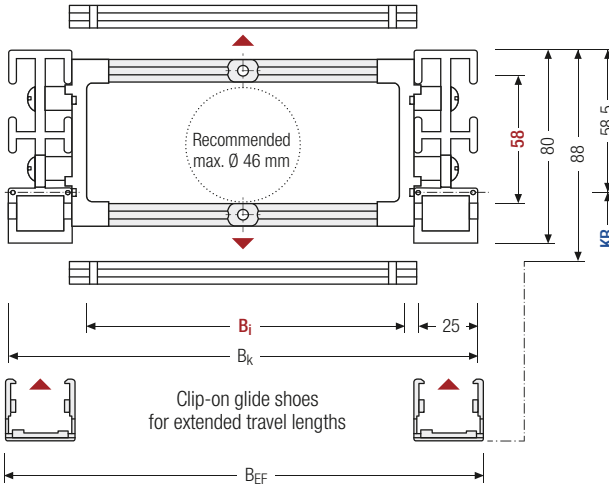

i The maximum cable diameter strongly depends on the bending radius and the desired cable type. Please contact us.

Calculating the cable carrier length

Cable carrier length L_k

$$L_k \approx \frac{L_s}{2} + L_B$$

Cable carrier length L_k rounded to pitch t

Technical support: technik@kabelschlepp.de

h _i [mm]	h _g [mm]	h _{g'} [mm]	B _i [mm]*	B _k [mm]	B _{EF} [mm]	KR [mm]					q _k [kg/m]	
58	80	88	50 – 600	B _i + 72	B _i + 79.5	170	200	250	320	420	500	1.90 – 2.25

* in 1 mm width sections

Order example

Q080
-
400
-
RS
-
250
-
1600
-
HS

Type
B_i [mm]
Stay variant
KR [mm]
L_k [mm]
Stay arrangement

Our technical support can provide help for gliding arrangements: technik@kabelschlepp.de

Divider systems

The divider system is mounted on each crossbar as a standard – on every 8th section for stay mounting (HS).

As a standard, dividers or the complete divider system (dividers with height separations) are movable in the cross section (**Version A**).

For applications with lateral acceleration and rotated by 90°, the dividers can be attached by simply clipping onto a socket (available as an accessory).

This socket additionally acts as a spacer between the dividers and is available in a 1 mm grid between 3 – 50 mm, as well as 16.5 and 21.5 mm (**Version B**).

Inner heights



Inner widths



Increments



Divider system TS0 without height separation

Vers.	a _T min [mm]	a _x min [mm]	a _c min [mm]	π _T min
A	11	14	10	–

The dividers can be moved in the cross section.

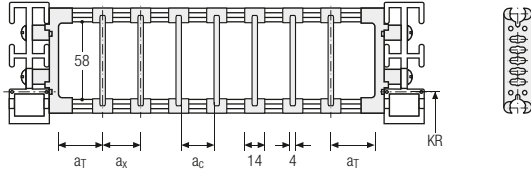

Divider system TS1 with continuous height separation

Vers.	a _T min [mm]	a _T max [mm]	a _x min [mm]	a _c min [mm]	π _T min
A	11	25	14	10	2

The dividers can be moved in the cross section.

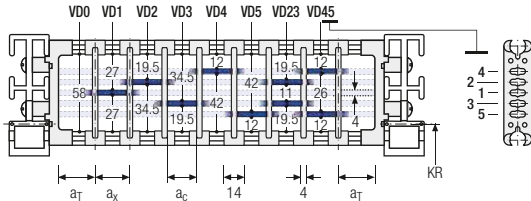

Divider system TS2 with partial height separation

Vers.	a _T min [mm]	a _x min [mm]	a _c min [mm]	π _T min
A	11	14	10	2

With grid distribution (1 mm grid).
The dividers are attached by the height separation; the grid can be moved in the cross section.

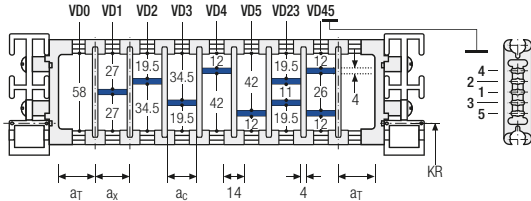

tsubaki-kabelschlepp.com/
quantum

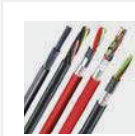

TRAXLINE® cables for cable carriers

Hi-flex electric cables which were especially developed, optimized and tested for use in cable carriers can be found at traxline.de

Q080 RV | Dimensions · Technical data

Aluminum stay RV – Frame stay reinforced

- Aluminum profile bars with plastic adapter for medium to high loads and large cable carrier widths. Assembly without screws.
- Available customized in **1 mm sections**.
- **Outside/inside:** release by rotating 90°.

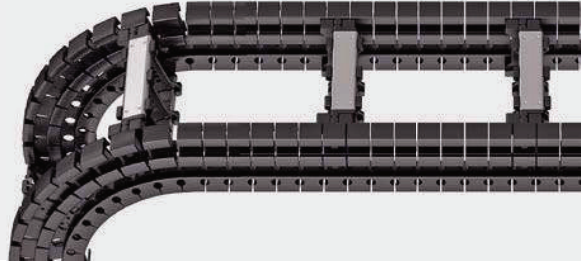

Key for abbreviations
on page 12

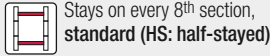

Stays on every 8th section,
standard (HS: half-stayed)



Stays on every 4th section
(VS: fully-stayed)



1 mm B_i 50 – 600 mm in
1 mm width sections

Design guidelines
from page 38

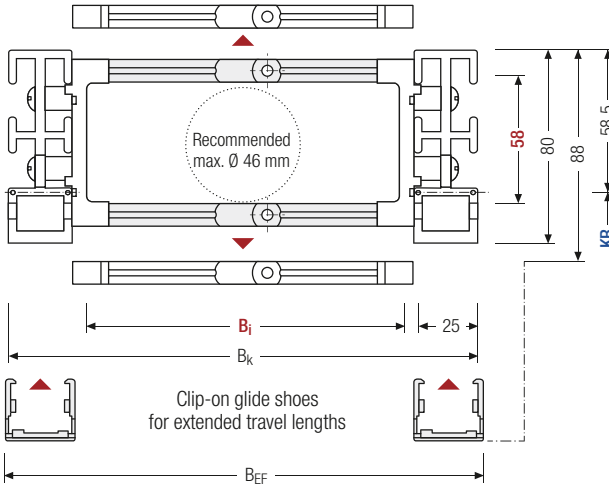

i The maximum cable diameter strongly depends on the bending radius and the desired cable type. Please contact us.

Calculating the cable carrier length

Cable carrier length L_k

$$L_k \approx \frac{L_s}{2} + L_B$$

Cable carrier length L_k
rounded to pitch t

Technical support:
technik@kabelschlepp.de

online-engineer.de
Cable Carrier Configurator

h _i [mm]	h _G [mm]	h _{G'} [mm]	B _i [mm]*	B _k [mm]	B _{EF} [mm]	KR [mm]					q _k [kg/m]	
58	80	88	50 – 600	B _i + 72	B _i + 79.5	170	200	250	320	420	500	2.10 – 2.90

* in 1 mm width sections

Order example

Q080 -
 400 -
 RV -
 250 -
 1600 -
 HS

Type B_i [mm] Stay variant KR [mm] L_k [mm] Stay arrangement

Our technical support can provide help for gliding arrangements: technik@kabelschlepp.de

Divider systems

The divider system is mounted on each crossbar as a standard – on every 8th section for stay mounting (HS).

As a standard, dividers or the complete divider system (dividers with height separations) are movable in the cross section (**Version A**).

Inner heights



Inner widths



Increments



Divider system TSO without height separation

Vers.	a _T min [mm]	a _x min [mm]	a _c min [mm]	n _T min
A	11	14	10	2

The dividers can be moved in the cross section.

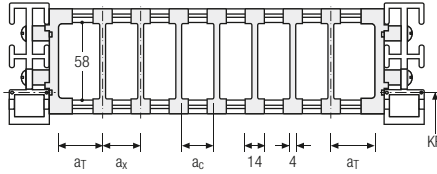

Divider system TS1 with continuous height separation

Vers.	a _T min [mm]	a _T max [mm]	a _x min [mm]	a _c min [mm]	n _T min
A	11	25	14	10	2

The dividers can be moved in the cross section.

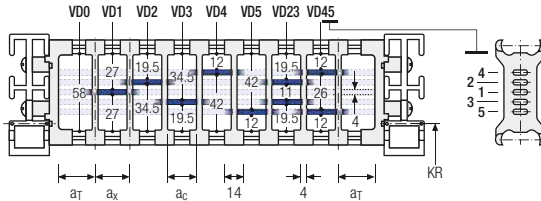

Divider system TS2 with partial height separation

Vers.	a _T min [mm]	a _x min [mm]	a _c min [mm]	n _T min
A	12	20	16	2

With grid distribution (1 mm grid). The dividers are attached by the height separation; the grid can be moved in the cross section.

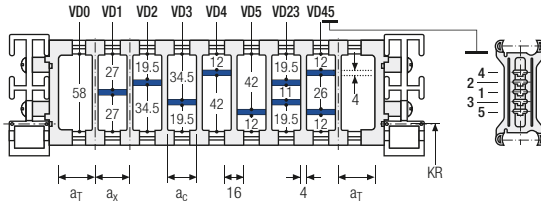

tsubaki-kabelschlepp.com/
quantum



TRAXLINE® cables for cable carriers

Hi-flex electric cables which were especially developed, optimized and tested for use in cable carriers can be found at traxline.de

Q080 RV | Inner distribution | TS3

Divider system TS3 with height separation consisting of plastic partitions

Vers.	a _T min [mm]	a _x min [mm]	a _c min [mm]	n _T min
A	8	16 / 42*	8	2

* For aluminum partitions

The dividers are fixed with the partitions.
The entire divider system can be moved in the cross section.

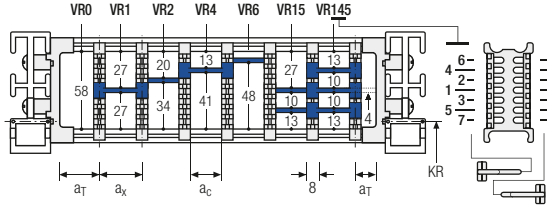

Key for abbreviations
on page 12

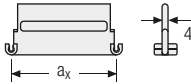

Aluminum partitions with 1 mm increments with a_x > 42 mm are also available.

a _x (center distance of dividers) [mm]											
a _c (nominal width of inner chamber) [mm]											
16	18	23	28	32	33	38	43	48	58	64	68
8	10	15	20	24	25	30	35	40	50	56	60
78	80	88	96	112	128	144	160	176	192	208	
70	72	80	88	104	120	136	152	168	184	200	

When using **plastic partitions with a_x > 112 mm**, we recommend an additional center support with a **twin divider** (S_T = 4 mm). Twin dividers are also suitable for retrofitting in the partition system.

Design guidelines
from page 38

Order example

TS3

A

3

K1

16

VR1

K5

208

VR7

Divider system

Version

n_T

Chamber

a_x

Height separation

Technical support:
technik@kabelschlepp.de

Please state the designation of the divider system (TS0, TS1,...), the version, and the number of dividers per cross section [n_T]. In addition, please also enter the chambers [K] from left to right, as well as the assembly distances [a_T/a_x].

When using divider systems with height separation (TS1 – TS3), please additionally state the positions (e.g. VD23) as seen from the left driver belt. You are welcome to add a sketch to your order.

online-engineer.de
Cable Carrier Configurator

More product information online



Assembly instructions etc.:
Additional info via your smartphone or check online at tsubaki-kabelschlepp.com/support



Configure your custom cable carrier here:
onlineengineer.de



QUANTUM®
series

Inner heights



Inner widths



Increments



[tsubaki-kabelschlepp.com/
quantum](http://tsubaki-kabelschlepp.com/quantum)

Q080 RE | Dimensions · Technical data

Plastic stay RE – frame screw-in stay

- Plastic profile bars for light and medium loads. Assembly without screws.
- Available customized in **16 mm sections**.
- **Outside/inside:** release by rotating 90°.

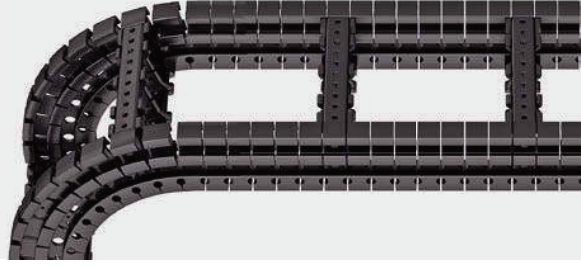

Key for abbreviations
on page 12



Stays on every 8th section,
standard (HS: half-stayed)



Stays on every 4th section
(VS: fully-stayed)



8 mm B_i 58 – 570 mm in
16 mm width sections

Design guidelines
from page 38

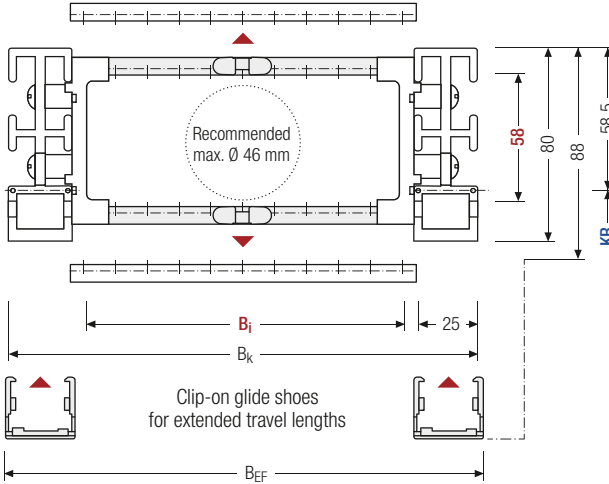

The maximum cable diameter strongly depends on the bending radius and the desired cable type. Please contact us.

Calculating the cable carrier length

Cable carrier length L_k

$$L_k \approx \frac{L_s}{2} + L_B$$

Cable carrier length L_k
rounded to pitch t

Technical support:
technik@kabelschlepp.de

online-engineer.de
Cable Carrier Configurator

h _i [mm]	h _G [mm]	h _{G'} [mm]	B _i [mm]*	B _k [mm]	B _{EF} [mm]	KR [mm]					q _k [kg/m]	
58	80	88	58 – 570	B _i + 72	B _i + 79.5	170	200	250	320	420	500	1.93 – 2.70

* in 16 mm width sections

Order example

Q080 - 196 - RE - 250 - 1600 - HS
 Type B_i [mm] Stay variant KR [mm] L_k [mm] Stay arrangement

Our technical support can provide help for gliding arrangements: technik@kabelschlepp.de

Divider systems

The divider system is mounted on each crossbar as a standard – on every 8th section for stay mounting (HS).

As a standard, dividers or the complete divider system (dividers with height separations) are movable in the cross section (**Version A**).

For applications with lateral accelerations and applications with the cable carrier rotated by 90°, the dividers can easily be fixed by turning the frame stay by 180°. The arresting cams click into place in the locking grids in the crossbar (**Version B**). The groove in the frame stay faces outwards.

Inner heights



Inner widths



Increments



Divider system TSO without height separation

Vers.	a _T min [mm]	a _x min [mm]	a _c min [mm]	a _x grid [mm]	n _T min
A	12	14.5	8.5	–	–
B	13	16	10	16	–

The dividers are movable within the cross section (version A) or fixed (version B).

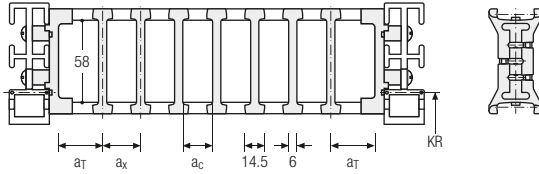

Divider system TS1 with continuous height separation

Vers.	a _T min [mm]	a _x min [mm]	a _c min [mm]	a _x grid [mm]	n _T min
A	12	14.5	8.5	–	2
B	13	16	10	16	2

The dividers are movable within the cross section (version A) or fixed (version B).

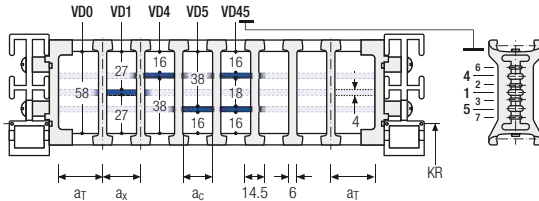

Divider system TS2 with partial height separation

Vers.	a _T min [mm]	a _x min [mm]	a _c min [mm]	n _T min
A	12	16	10	2
B	13	16	10	2

With grid distribution (8 mm grid). The dividers are attached by the height separation; the grid can be moved in the cross section.

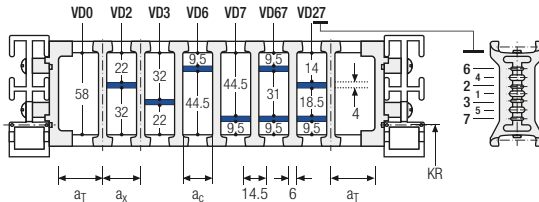

tsubaki-kabelschlepp.com/
quantum



TOTALTRAX® complete systems

Benefit from the advantages of the TOTALTRAX® complete system. A complete delivery from one source – with a warranty certificate on request! Learn more at tsubaki-kabelschlepp.com/totaltrax

Q080 RE | Inner distribution | TS3

Divider system TS3 with height separation consisting of plastic partitions

Vers.	a _T min [mm]	a _x min [mm]	a _c min [mm]	n _T min
A	8	16 / 42*	8	2

* For aluminum partitions

The dividers are fixed with the partitions. The entire divider system can be moved in the cross section.

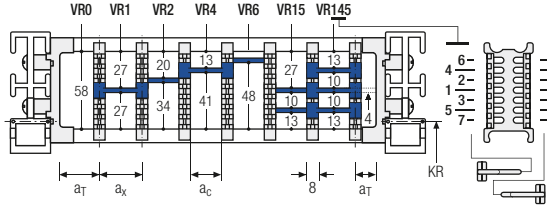

Key for abbreviations on page 12

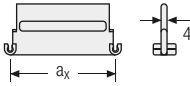

Aluminum partitions with 1 mm increments with a_x > 42 mm are also available.

a _x (center distance of dividers) [mm]											
a _c (nominal width of inner chamber) [mm]											
16	18	23	28	32	33	38	43	48	58	64	68
8	10	15	20	24	25	30	35	40	50	56	60
78	80	88	96	112	128	144	160	176	192	208	
70	72	80	88	104	120	136	152	168	184	200	

When using **plastic partitions with a_x > 112 mm**, we recommend an additional center support with a **twin divider** (S_T = 4 mm). Twin dividers are also suitable for retrofitting in the partition system.

Design guidelines from page 38

Order example



TS3	.	A	.	2	.	K1	.	16	-	VD1
						⋮		⋮		⋮
						K5	.	208	-	VD5
Divider system		Version		n _T		Chamber		a _x		Height separation

Please state the designation of the divider system (TS0, TS1,...), the version, and the number of dividers per cross section [n_T]. In addition, please also enter the chambers [K] from left to right, as well as the assembly distances [a_T/a_x].

When using divider systems with height separation (TS1 – TS3), please additionally state the positions (e.g. VD23) as seen from the left driver belt. You are welcome to add a sketch to your order.

Technical support: technik@kabelschlepp.de



TOTALTRAX® complete systems

Benefit from the advantages of the TOTALTRAX® complete system. A complete delivery from one source – with a warranty certificate on request! Learn more at tsubaki-kabelschlepp.com/totaltrax



TRAXLINE® cables for cable carriers

Hi-flex electric cables which were especially developed, optimized and tested for use in cable carriers can be found at traxline.de

Q080 | End connectors

Universal end connectors UMB – plastic (standard)

The universal end connectors (UMB) are made from plastic and can be mounted from the top, from the bottom or face on.

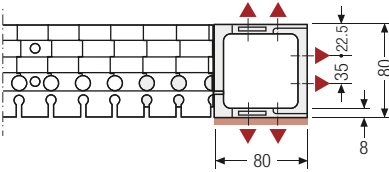

▲ Assembly options

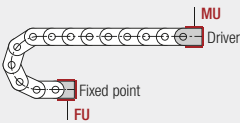
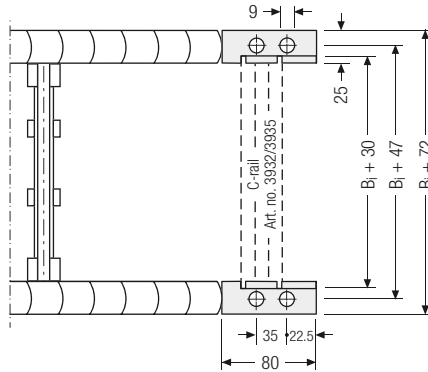

Connection point

- F – fixed point
- M – driver

Connection type

- U – universal end connector

Order example



UMB	.	F	U
UMB	.	M	U
End connector		Connection point	Connection type



We recommend the use of strain reliefs before driver and fixed point. See from p. 706.

More product information online



Assembly instructions etc.:
Additional info via your smartphone or check online at tsubaki-kabelschlepp.com/support



Configure your custom cable carrier here:
onlineengineer.de

Inner heights



Inner widths



Q100

Key for abbreviations
on page 12

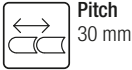

Pitch
30 mm



Inner height
72 mm

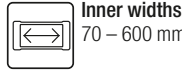

Inner widths
70 – 600 mm

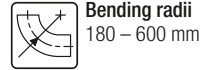

Bending radii
180 – 600 mm

Stay variants

Design guidelines
from page 38

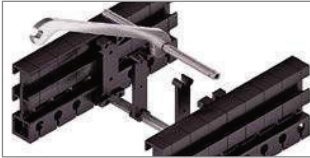

Aluminum stay RS page 396

Standard frame stay “The standard”

- Aluminum profile bars for light to medium loads.
Assembly without screws.
- **Outside/inside:** release by rotating 90°.

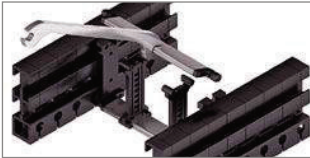

Aluminum stay RV page 398

Frame stay, reinforced

- Aluminum profile bars with plastic adapter for medium to high loads and large cable carrier widths.
Assembly without screws.
- **Outside/inside:** release by rotating 90°.

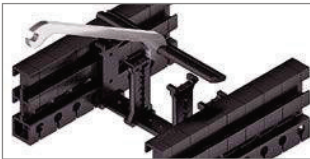

Plastic stay RE page 402

Frame screw-in stay

- Plastic profile bars for light and medium loads.
Assembly without screws.
- **Outside/inside:** release by rotating 90°.

Technical support:
technik@kabelschlepp.de



TOTALTRAX® complete systems

Benefit from the advantages of the TOTALTRAX® complete system. A complete delivery from one source – with a warranty certificate on request! Learn more at tsubaki-kabelschlepp.com/totaltrax



TRAXLINE® cables for cable carriers

Hi-flex electric cables which were especially developed, optimized and tested for use in cable carriers can be found at traxline.de

Q100 | Installation dim. | Unsupported · Gliding

Unsupported arrangement

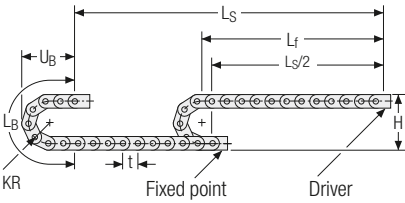

KR [mm]	H [mm]	L _B [mm]	U _B [mm]
180	503	926	432
250	643	1145	502
300	743	1302	552
370	883	1522	622
460	1063	1805	712
600	1343	2244	852

Inner heights



Inner widths



Load diagram for unsupported length depending on the additional load.

Sagging of the cable carrier is technically permitted for extended travel lengths, depending on the specific application.

Intrinsic cable carrier weight $q_k = 3.25 \text{ kg/m}$. For other inner widths, the maximum additional load changes.

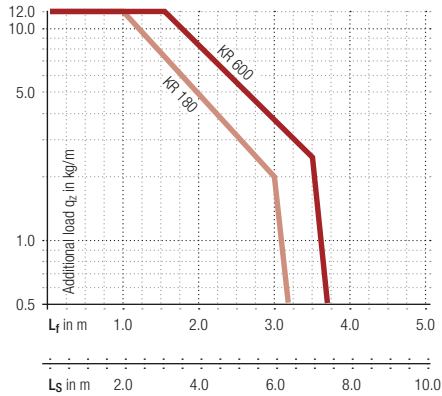

Velocity
up to 20 m/s



Acceleration
up to 70 m/s²



Travel length
up to 7.8 m



Additional load
up to 12 kg/m

tsubaki-kabelschlepp.com/
quantum

Gliding arrangement

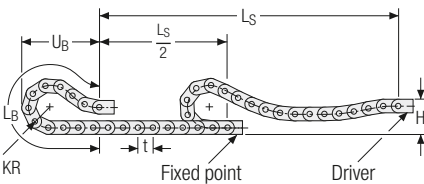

Velocity
up to 10 m/s



Acceleration
up to 5 m/s²



Travel length
up to 200 m



Additional load
up to 12 kg/m

Glide shoes have to be used for gliding applications.

The gliding cable carrier has to be routed in a channel.
See p. 654.



Our technical support can provide help for gliding arrangements:
technik@kabelschlepp.de

Q100 RS | Dimensions · Technical data

Aluminum stay RS – standard frame stay

- Extremely quick to open and close.
- Aluminum profile bars for light to medium loads.
Assembly without screws.
- Available customized in **1 mm sections**.
- **Outside/inside:** release by rotating 90°.



Key for abbreviations
on page 12



Stays on every 8th section,
standard (HS: half-stayed)



Stays on every 4th section
(VS: fully-stayed)



1 mm B_i 70 – 600 mm in
1 mm width sections

Design guidelines
from page 38

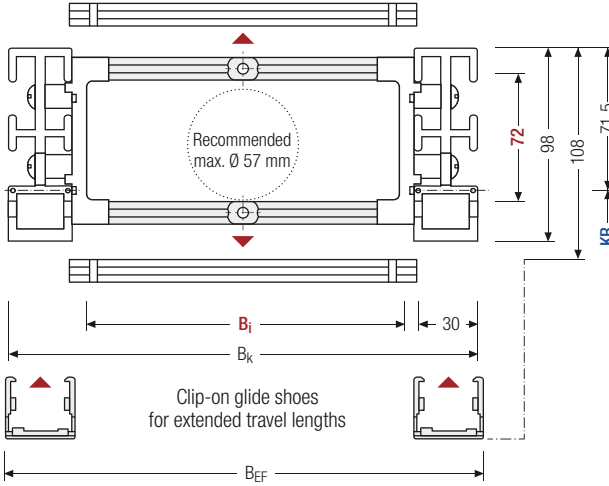

The maximum cable diameter strongly depends on the bending radius and the desired cable type. Please contact us.

Calculating the cable carrier length

Cable carrier length L_k

$$L_k \approx \frac{L_s}{2} + L_B$$

Cable carrier length L_k rounded to pitch t

Technical support:
technik@kabelschlepp.de

online-engineer.de
Cable Carrier Configurator

h _i [mm]	h _g [mm]	h _{g'} [mm]	B _i [mm]*	B _k [mm]	B _{EF} [mm]	KR [mm]		q _k [kg/m]
72	98	108	70 – 600	B _i + 82	B _i + 89.5	180	250 300 370 460 600	2.6 – 3.4

* in 1 mm width sections

Order example

Q100 -
 400 -
 RS -
 370 -
 1860 -
 HS
Type B_i [mm] Stay variant KR [mm] L_k [mm] Stay arrangement

Our technical support can provide help for gliding arrangements: technik@kabelschlepp.de

Divider systems

The divider system is mounted on each crossbar as a standard – on every 8th section for stay mounting (HS).

As a standard, dividers or the complete divider system (dividers with height separations) are movable in the cross section (**Version A**).

For applications with lateral acceleration and rotated by 90°, the dividers can be attached by simply clipping onto a socket (available as an accessory).

The socket additionally acts as a spacer between the dividers and is available in 1 mm sections between 3 – 50 mm (**Version B**).

Inner heights



Inner widths



Increments



Divider system TSO without height separation

Vers.	a _T min [mm]	a _x min [mm]	a _c min [mm]	n _T min
A	7.5	15	10	–

The dividers can be moved in the cross section.

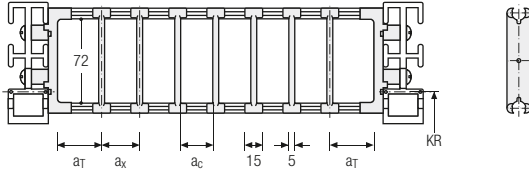

Divider system TS1 with continuous height separation

Vers.	a _T min [mm]	a _T max [mm]	a _x min [mm]	a _c min [mm]	n _T min
A	7.5	25	15	10	2

The dividers can be moved in the cross section.

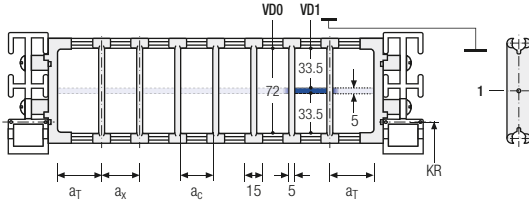

tsubaki-kabelschlepp.com/
quantum

Order example

TS1 .
 A .
 3 -
 VD1
 :
 - VD3
 Divider system Version n_T Height separation

Please state the designation of the divider system (**TS0, TS1, ...**), the version, and the number of dividers per cross section [n_T].

When using divider systems with height separation (**TS1**), please additionally state the positions (e.g. VD1) as seen from the left driver belt. You are welcome to add a sketch to your order.

Aluminum stay RV – Frame stay reinforced

- Aluminum profile bars with plastic adapter for medium to high loads and large cable carrier widths. Assembly without screws.
- Available customized in **1 mm sections**.
- **Outside/inside:** release by rotating 90°.



Key for abbreviations
on page 12

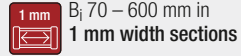
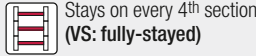
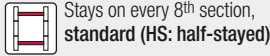

Design guidelines
from page 38

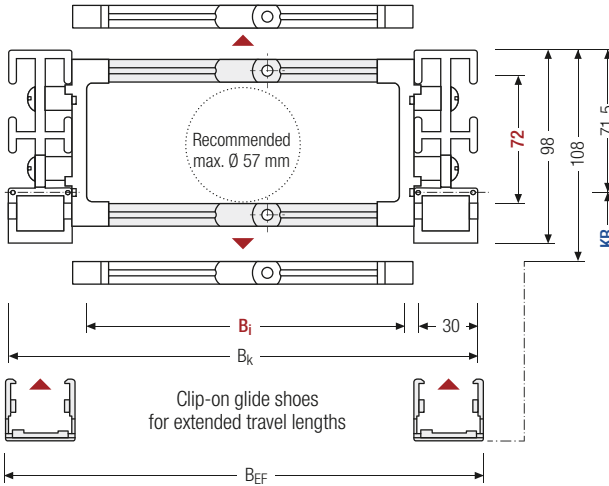

The maximum cable diameter strongly depends on the bending radius and the desired cable type. Please contact us.

Calculating the cable carrier length

Cable carrier length L_k

$$L_k \approx \frac{L_s}{2} + L_B$$

Cable carrier length L_k
rounded to pitch t

Technical support:
technik@kabelschlepp.de

online-engineer.de
Cable Carrier Configurator

h_i [mm]	h_g [mm]	h_g' [mm]	B_i [mm]*	B_k [mm]	B_{EF} [mm]	KR [mm]				q_k [kg/m]		
72	98	108	70 – 600	$B_i + 82$	$B_i + 89.5$	180	250	300	370	460	600	2.8 – 4.6

* in 1 mm width sections

Order example

Q100 -
 400 B_i [mm] -
 RV -
 370 KR [mm] -
 1860 L_k [mm] -
 HS Stay arrangement

Our technical support can provide help for gliding arrangements: technik@kabelschlepp.de

Divider systems

The divider system is mounted on each crossbar as a standard – on every 8th section for stay mounting (HS).

As a standard, dividers or the complete divider system (dividers with height separations) are movable in the cross section (**Version A**).

Inner heights



Inner widths



Increments



tsubaki-kabelschlepp.com/quantum

Divider system TSO without height separation

Vers.	a _T min [mm]	a _x min [mm]	a _c min [mm]	n _T min
A	13	16	10	2

The dividers can be moved in the cross section.

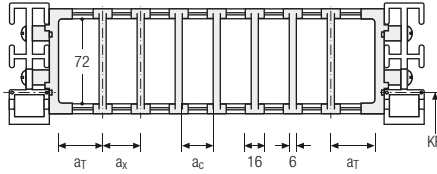

Divider system TS1 with continuous height separation

Vers.	a _T min [mm]	a _T max [mm]	a _x min [mm]	a _c min [mm]	n _T min
A	13	25	16	10	2

The dividers can be moved in the cross section.

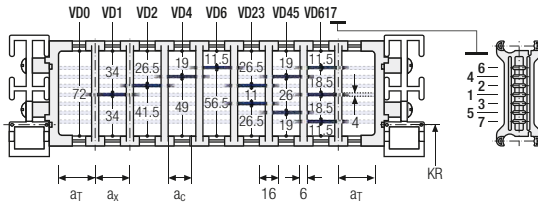

Divider system TS2 with partial height separation

Vers.	a _T min [mm]	a _x min [mm]	a _c min [mm]	n _T min
A	13	20	14	2

With grid distribution (**1 mm grid**). The dividers are attached by the height separation; the grid can be moved in the cross section.

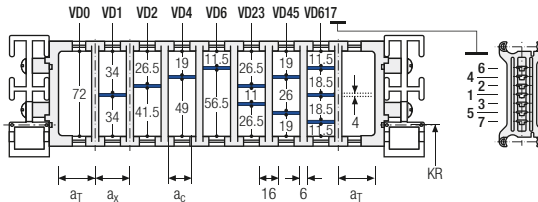

TRAXLINE® cables for cable carriers

Hi-flex electric cables which were especially developed, optimized and tested for use in cable carriers can be found at traxline.de

Q100 RV | Inner distribution | TS3

Divider system TS3 with height separation consisting of plastic partitions

Vers.	a _T min [mm]	a _x min [mm]	a _c min [mm]	n _T min
A	4	16/42*	8	2

* For aluminum partitions

The dividers are fixed with the partitions. The entire divider system can be moved in the cross section.

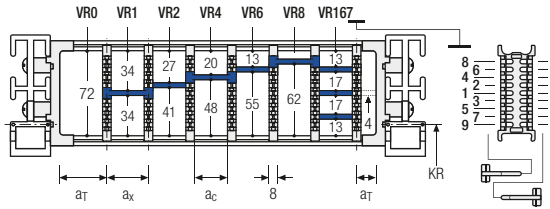

Key for abbreviations on page 12

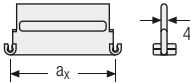

Aluminum partitions with 1 mm increments with a_x > 42 mm are also available.

a _x (center distance of dividers) [mm]											
a _c (nominal width of inner chamber) [mm]											
16	18	23	28	32	33	38	43	48	58	64	68
8	10	15	20	24	25	30	35	40	50	56	60
78	80	88	96	112	128	144	160	176	192	208	
70	72	80	88	104	120	136	152	168	184	200	

When using plastic partitions with a_x > 112 mm, we recommend an additional center support with a twin divider (S_T = 4 mm). Twin dividers are also suitable for retrofitting in the partition system.

Design guidelines from page 38

Order example



TS3	A	3	K1	16	VR1
			⋮	⋮	⋮
			K8	208	VR9
Divider system	Version	n _T	Chamber	a _x	Height separation

Please state the designation of the divider system (TS0, TS1,...), the version, and the number of dividers per cross section [n_T]. In addition, please also enter the chambers [K] from left to right, as well as the assembly distances [a_T/a_x].

When using divider systems with height separation (TS1 – TS3), please additionally state the positions (e.g. VD23) as seen from the left driver belt. You are welcome to add a sketch to your order.

Technical support: technik@kabelschlepp.de

online-engineer.de
Cable Carrier Configurator

More product information online



Assembly instructions etc.: Additional info via your smartphone or check online at tsubaki-kabelschlepp.com/support



Configure your custom cable carrier here: onlineengineer.de

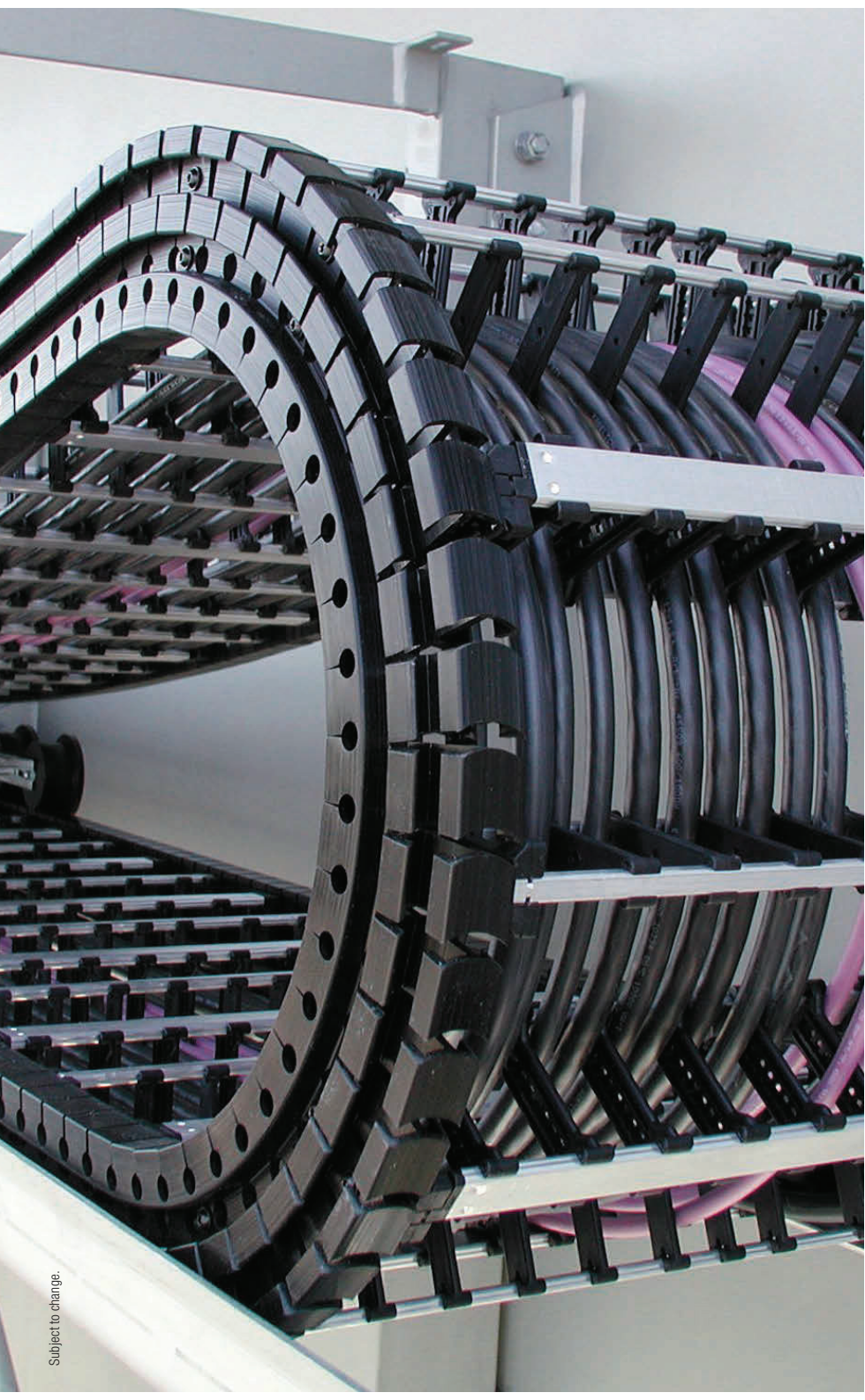

QUANTUM®
series

Inner heights



Inner widths



Increments



[tsubaki-kabelschlepp.com/
quantum](http://tsubaki-kabelschlepp.com/quantum)

Subject to change.

Q100 RE | Dimensions · Technical data

Plastic stay RE – frame screw-in stay

- Plastic profile bars for light and medium loads. Assembly without screws.
- Available customized in **16 mm sections**.
- **Outside/inside:** release by rotating 90°.



Key for abbreviations
on page 12



Stays on every 8th section,
standard (HS: half-stayed)



Stays on every 4th section
(VS: fully-stayed)



8 mm B_i 74 – 570 mm in
16 mm width sections

Design guidelines
from page 38

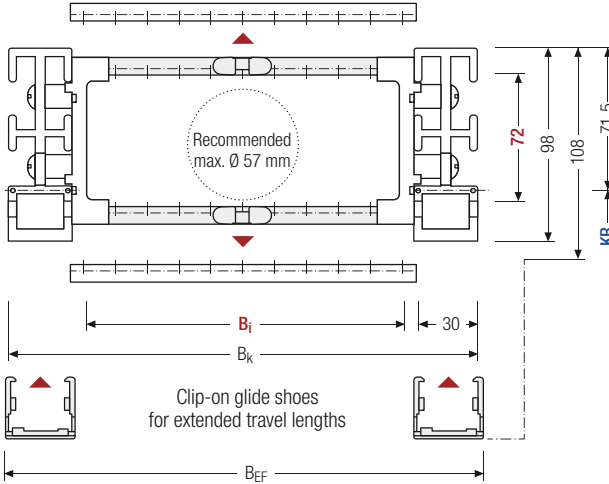

i The maximum cable diameter strongly depends on the bending radius and the desired cable type. Please contact us.

Calculating the cable carrier length

Cable carrier length L_k

$$L_k \approx \frac{L_s}{2} + L_B$$

Cable carrier length L_k
rounded to pitch t

Technical support:
technik@kabelschlepp.de

h_i [mm]	h_G [mm]	$h_{G'}$ [mm]	B_i [mm]*	B_k [mm]	B_{EF} [mm]	KR [mm]		q_k [kg/m]
72	98	108	74 – 570	$B_i + 82$	$B_i + 89.5$	180	250 300 370	2.74 – 3.67

* in 16 mm width sections

Order example

Q100 -
 346 -
 RE -
 370 -
 1860 -
 HS

Type B_i [mm] Stay variant KR [mm] L_k [mm] Stay arrangement

Our technical support can provide help for gliding arrangements: technik@kabelschlepp.de

Q100 RE | Inner distribution | TSO · TS1 · TS2

Divider systems

The divider system is mounted on each crossbar as a standard – on every 8th section for stay mounting (HS).

As a standard, dividers or the complete divider system (dividers with height separations) are movable in the cross section (**Version A**).

For applications with lateral accelerations and applications with the cable carrier rotated by 90°, the dividers can easily be fixed by turning the frame stay by 180°. The arresting cams click into place in the locking grids in the crossbar (**Version B**).
The groove in the frame stay faces outwards.

Inner heights



Inner widths



Increments



Divider system TSO without height separation

Vers.	a _T min [mm]	a _x min [mm]	a _c min [mm]	a _x grid [mm]	Π _T min
A	12	14.5	6.5	–	–
B	13	16	8	16	–

The dividers are movable within the cross section (version A) or fixed (version B).

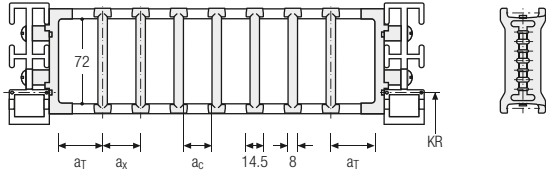

Divider system TS1 with continuous height separation

Vers.	a _T min [mm]	a _x min [mm]	a _c min [mm]	a _x grid [mm]	Π _T min
A	12	14.5	6.5	–	2
B	13	16	8	16	2

The dividers are movable within the cross section (version A) or fixed (version B).

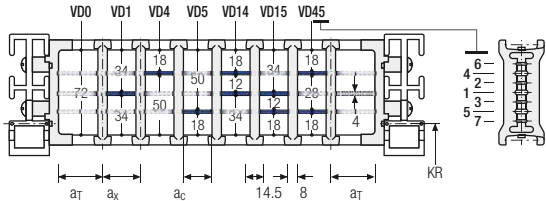

Divider system TS2 with partial height separation

Vers.	a _T min [mm]	a _x min [mm]	a _c min [mm]	a _x grid [mm]	Π _T min
A	12	14.5*/ 20	6.5*/ 12	–	2
B	13	16*/ 32	8*/ 24	16	2

* for VR0

With grid distribution (16 mm grid). The dividers are fixed by the height separation; the grid is movable in the cross section (version A) or fixed (version B).

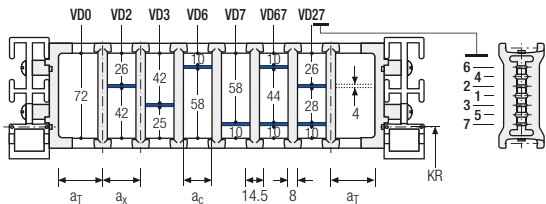

Q100 RE | Inner distribution | TS3

Divider system TS3 with height separation consisting of plastic partitions

Vers.	a _T min [mm]	a _x min [mm]	a _c min [mm]	n _T min
A	4	16/42*	8	2

* For aluminum partitions

The dividers are fixed with the partitions.
The entire divider system can be moved in the cross section.

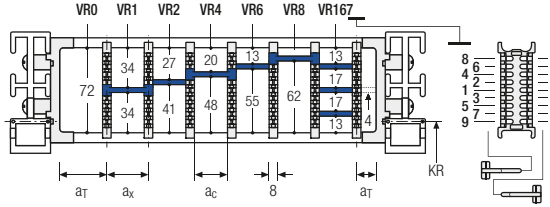

Key for abbreviations
on page 12

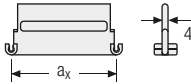

Aluminum partitions with 1 mm increments with a_x > 42 mm are also available.

a _x (center distance of dividers) [mm]											
a _c (nominal width of inner chamber) [mm]											
16	18	23	28	32	33	38	43	48	58	64	68
8	10	15	20	24	25	30	35	40	50	56	60
78	80	88	96	112	128	144	160	176	192	208	
70	72	80	88	104	120	136	152	168	184	200	

When using plastic partitions with a_x > 112 mm, we recommend an additional center support with a twin divider (s_T = 4 mm). Twin dividers are also suitable for retrofitting in the partition system.

Design guidelines
from page 38

Order example

TS3	.	A	.	2	.	K1	.	16	-	VD1
⋮		⋮		⋮		⋮		⋮		⋮
K5	.	208	-	VD9						

Divider system
Version
n_T
Chamber
a_x
Height separation

Please state the designation of the divider system (TS0, TS1,...), the version, and the number of dividers per cross section [n_T]. In addition, please also enter the chambers [K] from left to right, as well as the assembly distances [a_T/a_x].

When using divider systems with height separation (TS1 – TS3), please additionally state the positions (e.g. VD23) as seen from the left driver belt. You are welcome to add a sketch to your order.

Technical support:
technik@kabelschlepp.de



TOTALTRAX® complete systems

Benefit from the advantages of the TOTALTRAX® complete system. A complete delivery from one source – with a warranty certificate on request! Learn more at tsubaki-kabelschlepp.com/totaltrax



TRAXLINE® cables for cable carriers

Hi-flex electric cables which were especially developed, optimized and tested for use in cable carriers can be found at traxline.de

Q100 | End connectors

Universal end connectors UMB – plastic (standard)

The universal end connectors (UMB) are made from plastic and can be mounted from the top, from the bottom or face on.

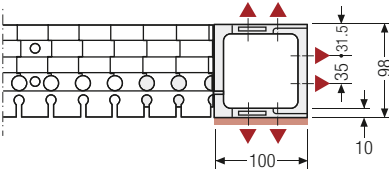

▲ Assembly options

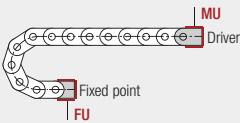
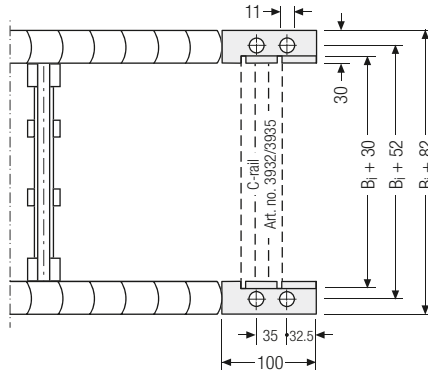

Connection point

- F – fixed point
- M – driver

Connection type

- U – universal end connector

Order example



UMB	.	F	U
UMB	.	M	U
End connector		Connection point	Connection type



We recommend the use of strain reliefs before driver and fixed point. See from p. 706.

More product information online



Assembly instructions etc.:
Additional info via your smartphone or check online at tsubaki-kabelschlepp.com/support



Configure your custom cable carrier here:
onlineengineer.de

Inner heights



Inner widths

